



Data-Sheet-Variable Vacuum Capacitor CKTB2000/2.1/86 (I)



www.glvac.cn

Specification	
Capacity C_{max} (nominal)	2000pF
Capacity C_{min} (nominal)	200pF
Voltage (Peak Test U_{pt} /Peak Working U_{pw})	3kV/1.8kV
Capacity tolerance (liner Range)	10%
Max. Current I_{max} at 13.56MHz with	86Arms
Conduction Cooling	20W
Capacitance per turn	189pF/turn
Torque	$\leq 0.2Nm$
Net Weight	0.7kg

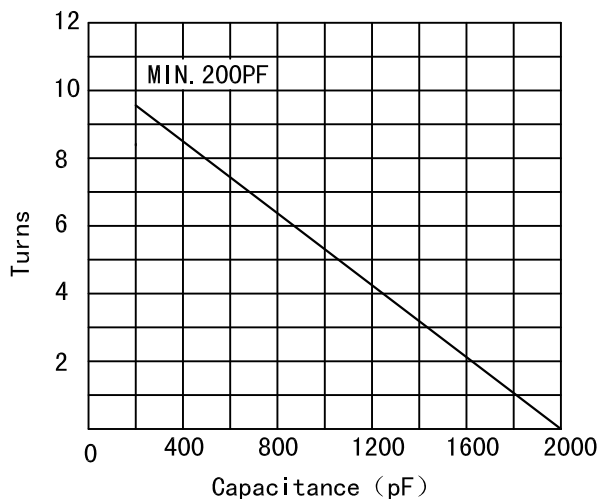
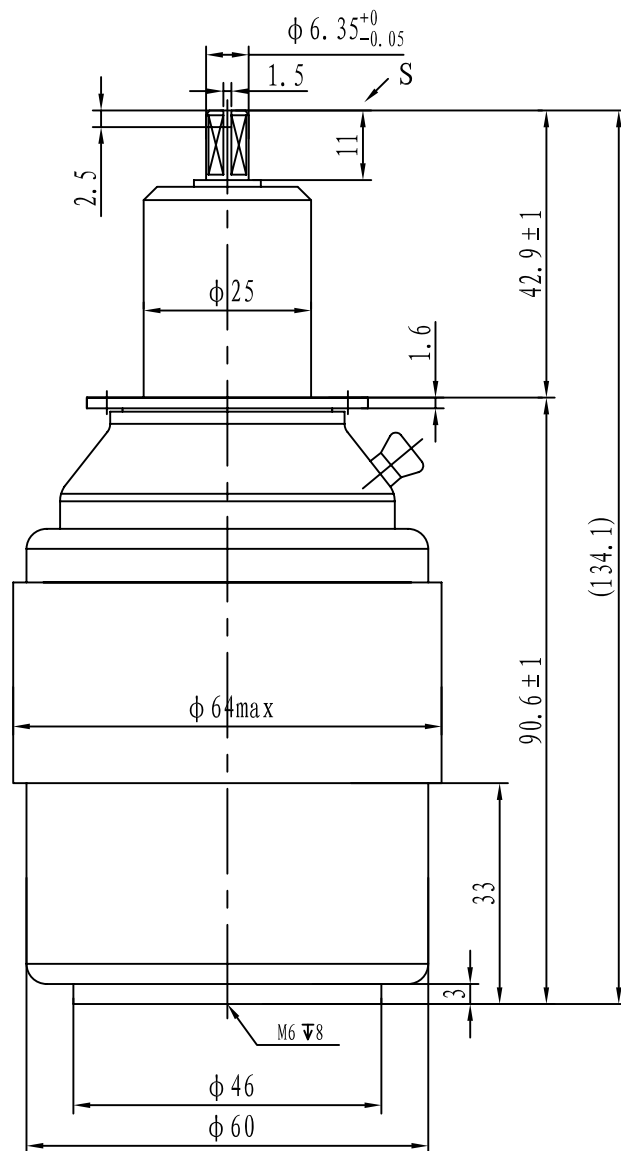

I_{max} at ambient and 125 °C surface temp. for convection and conduction (20w) cooling

